



High-Frequency, Current-Mode PWM Controller with Accurate Programmable Oscillator

MAX5068

General Description

The MAX5068 is a high-frequency, current-mode, pulse-width modulation (PWM) controller that integrates all the building blocks necessary for implementing AC-DC or DC-DC fixed-frequency power supplies. Isolated or nonisolated power supplies are easily constructed using either primary- or secondary-side regulation. Current-mode control with leading-edge blanking simplifies control-loop design, and a programmable internal slope-compensation circuit stabilizes the current loop when operating at duty cycles above 50%. The MAX5068A/B limit the maximum duty cycle to 50% for use in single-ended forward converters. The MAX5068C/D/E/F allow duty cycles up to 75%. The MAX5068 features an accurate externally programmable oscillator that simplifies system design.

An input undervoltage lockout (UVLO) programs the input-supply startup voltage and ensures proper operation during brownout conditions.

A single external resistor programs the output switching frequency from 12.5kHz to 1.25MHz. The MAX5068A/B/C/E provide a SYNC input for synchronization to an external clock. The maximum FET-driver duty cycle is 50% for the MAX5068A/B and 75% for the MAX5068C/D/E/F. Programmable hiccup current limit provides additional protection under severe faults.

The MAX5068 is specified over the -40°C to +125°C automotive temperature range and is available in a 16-pin thermally enhanced TSSOP-EP package. Refer to the MAX5069 data sheet for dual FET-driver applications.

Warning: The MAX5068 is designed to work with high voltages. Exercise caution.

Applications

- Universal-Input AC Power Supplies
- Isolated Telecom Power Supplies
- Networking System Power Supplies
- Server Power Supplies
- Industrial Power Conversion

Selector Guide appears at end of data sheet.



Features

- ◆ Current-Mode Control with 47μA (typ) Startup Current
- ◆ Resistor-Programmable ±4.5% Accurate Switching Frequency:
 - 25kHz to 1.25MHz (MAX5068A/B)
 - 12.5kHz to 625kHz (MAX5068C/D/E/F)
- ◆ Rectified 85V_{AC} to 265V_{AC} or 36V_{DC} to 72V_{DC} Input (MAX5068A/C/D)
- ◆ Input Directly Driven from 10.8V to 24V (MAX5068B/E/F)
- ◆ Frequency Synchronization Input (MAX5068A/B/C/E)
- ◆ Programmable Dead Time and Slope Compensation
- ◆ Programmable Startup Voltage (UVLO)
- ◆ Programmable UVLO Hysteresis (MAX5068A/B/D/F)
- ◆ Integrating Fault Protection (Hiccup)
- ◆ -40°C to +125°C Automotive Temperature Range
- ◆ 16-Pin Thermally Enhanced TSSOP-EP Package

Ordering Information

PART	TEMP RANGE	PIN-PACKAGE
MAX5068AAUE	-40°C to +125°C	16 TSSOP-EP*
MAX5068BAUE	-40°C to +125°C	16 TSSOP-EP*
MAX5068CAUE	-40°C to +125°C	16 TSSOP-EP*
MAX5068DAUE	-40°C to +125°C	16 TSSOP-EP*
MAX5068EAUE	-40°C to +125°C	16 TSSOP-EP*
MAX5068FAUE	-40°C to +125°C	16 TSSOP-EP*

*EP = Exposed pad.

Pin Configurations

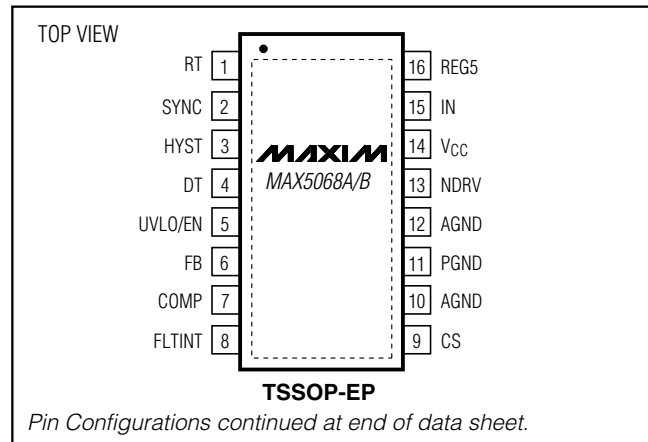

High-Frequency, Current-Mode PWM Controller with Accurate Programmable Oscillator

ABSOLUTE MAXIMUM RATINGS

IN to PGND	-0.3V to +30V
IN to AGND	-0.3V to +30V
V _{CC} to PGND	-0.3V to +13V
V _{CC} to AGND	-0.3V to +13V
FB, COMP, CS, HYST, SYNC, REG5 to AGND	-0.3V to +6V
UVLO/EN, RT, DT, SCOMP, FLTINT to AGND	-0.3V to +6V
NDRV to PGND	-0.3V to (V _{CC} + 0.3V)

AGND to PGND	-0.3V to +0.3V
Continuous Power Dissipation	
16-Pin TSSOP-EP (derate 21.3mW/°C above +70°C) ...	1702mW
Operating Temperature Range	-40°C to +125°C
Maximum Junction Temperature	+150°C
Storage Temperature Range	-60°C to +150°C
Lead Temperature (soldering, 10s)	+300°C

Stresses beyond those listed under "Absolute Maximum Ratings" may cause permanent damage to the device. These are stress ratings only, and functional operation of the device at these or any other conditions beyond those indicated in the operational sections of the specifications is not implied. Exposure to absolute maximum rating conditions for extended periods may affect device reliability.

ELECTRICAL CHARACTERISTICS

(V_{IN} = +12V for the MAX5068B/E/F; V_{IN} = +23.6V for the MAX5068A/C/D at startup, then reduces to +12V; C_{IN} = C_{REG5} = 0.1μF; C_{VCC} = 1μF; R_{RT} = 100kΩ; NDRV = floating; T_A = T_{MIN} to T_{MAX}, unless otherwise noted. Typical values are at T_A = +25°C.) (Note 1)

PARAMETER	SYMBOL	CONDITIONS	MIN	TYP	MAX	UNITS
UNDERVOLTAGE LOCKOUT/STARTUP						
Bootstrap UVLO Wake-Up Level	V _{SUVR}	V _{IN} rising, MAX5068A/C/D only	19.68	21.6	23.60	V
Bootstrap UVLO Shutdown Level	V _{SUVF}	V _{IN} falling, MAX5068A/C/D only	9.05	9.74	10.43	V
UVLO/EN Wake-Up Threshold	V _{ULR2}	V _{UVLO/EN} rising	1.205	1.230	1.255	V
UVLO/EN Shutdown Threshold	V _{ULF2}	V _{UVLO/EN} falling		1.18		V
HYST FET On-Resistance	R _{DS(ON)_H}	MAX5068A/B/D/F only, sinking 50mA, V _{UVLO/EN} = 0V		10		Ω
HYST FET Leakage Current	I _{LEAK_H}	V _{UVLO/EN} = 2V, V _{HYST} = 5V		3		nA
IN Supply Current In Undervoltage Lockout	I _{START}	V _{IN} = +19V, V _{UVLO/EN} < V _{ULF2}		47	90	μA
IN Range	V _{IN}		10.8		24.0	V
INTERNAL SUPPLIES (V_{CC} and REG5)						
V _{CC} Regulator Set Point	V _{CCSP}	V _{IN} = +10.8V to +24V, V _{CC} sourcing 1μA to 25mA	7.0		10.5	V
REG5 Output Voltage	V _{REG5}	I _{REG5} = 0 to 1mA	4.85	5.00	5.15	V
REG5 Short-Circuit Current Limit	I _{REG5_SC}			18		mA
IN Supply Current After Startup	I _{IN}	V _{IN} = +24V	f _{sw} = 1.25MHz		5	mA
			f _{sw} = 100kHz		2.5	
Shutdown Supply Current	I _{IN_SD}				90	μA
GATE DRIVER (NDRV)						
Driver Output Impedance	Z _{OUT(LOW)}	NDRV sinking 100mA		2	4	Ω
	Z _{OUT(HIGH)}	NDRV sourcing 25mA		3	6	
Driver Peak Output Current	I _{NDRV}	Sinking		1000		mA
		Sourcing		650		
PWM COMPARATOR						
Comparator Offset Voltage	V _{OS_PWM}	V _{COMP} - V _{CS}	1.30	1.60	2.00	V
Comparator Propagation Delay	t _{PD_PWM}	V _{CS} = 0.1V		40		ns
Minimum On-Time	t _{ON(MIN)}	Includes t _{CS_BLANK}		110		ns
CURRENT-LIMIT COMPARATOR						
Current-Limit Trip Threshold	V _{CS}		298	314	330	mV

High-Frequency, Current-Mode PWM Controller with Accurate Programmable Oscillator

MAX5068

ELECTRICAL CHARACTERISTICS (continued)

($V_{IN} = +12V$ for the MAX5068B/E/F; $V_{IN} = +23.6V$ for the MAX5068A/C/D at startup, then reduces to $+12V$; $C_{IN} = C_{REG5} = 0.1\mu F$; $C_{VCC} = 1\mu F$; $R_{RT} = 100k\Omega$; $NDRV = floating$; $T_A = T_{MIN}$ to T_{MAX} , unless otherwise noted. Typical values are at $T_A = +25^\circ C$.) (Note 1)

PARAMETER	SYMBOL	CONDITIONS	MIN	TYP	MAX	UNITS
CS Input Bias Current	I_{B_CS}	$V_{CS} = 0V$	0		+2	μA
CS Blanking Time	t_{CS_BLANK}			70		ns
Propagation Delay from Comparator Input to NDRV		50mV overdrive		40		ns
IN CLAMP VOLTAGE						
IN Clamp Voltage	V_{IN_CLAMP}	V_{IN} sinking 2mA (Note 2)	24.0	26.0	29.0	V
ERROR AMPLIFIER (FB, COMP)						
Voltage Gain	A_V	$R_{COMP} = 100k\Omega$ to AGND		80		dB
Unity-Gain Bandwidth	BW	$R_{COMP} = 100k\Omega$ to AGND, $C_{LOAD} = 100pF$ to AGND		5		MHz
Phase Margin	PM	$R_{COMP} = 100k\Omega$ to AGND, $C_{LOAD} = 100pF$ to AGND		65		degrees
FB Input Offset Voltage	V_{OS_FB}				3	mV
COMP Clamp Voltage	V_{COMP}	High	2.6		3.8	V
		Low	0.4		1.1	
Error-Amplifier Output Current	I_{COMP}	Sinking or sourcing	0.5			mA
Reference Voltage	V_{REF}	$+25^\circ C \leq T_A \leq +125^\circ C$ (Note 3)	1.215	1.230	1.245	V
		$-40^\circ C \leq T_A \leq +125^\circ C$	1.205	1.230	1.242	
Input Bias Current	I_{B_EA}			100	300	nA
COMP Short-Circuit Current	I_{COMP_SC}			12		mA
THERMAL SHUTDOWN						
Thermal-Shutdown Temperature	T_{SD}			+170		$^\circ C$
Thermal Hysteresis	T_{HYST}			+25		$^\circ C$
OSCILLATOR SYNC INPUT (MAX5068A/B/C/E Only)						
SYNC High-Level Voltage	V_{IH_SYNC}		2.4			V
SYNC Low-Level Voltage	V_{IL_SYNC}				0.4	V
SYNC Input Bias Current	I_{B_SYNC}			10		nA
Maximum SYNC Frequency	f_{SYNC}	$f_{OSC} = 2.5MHz$ (Note 4)	3.125			MHz
SYNC High-Level Pulse Width	t_{SYNC_HI}		30			ns
SYNC Low-Level Pulse Width	t_{SYNC_LO}		30			ns
DIGITAL SOFT-START						
Soft-Start Duration	t_{SS}	(Note 5)		2047		cycles
Reference-Voltage Step	V_{STEP}			9.7		mV
Reference-Voltage Steps During Soft-Start				127		steps
OSCILLATOR						
Internal Oscillator Frequency Range	f_{OSC}	$f_{OSC} = (10^{11} / R_{RT})$	50		2500	kHz

High-Frequency, Current-Mode PWM Controller with Accurate Programmable Oscillator

ELECTRICAL CHARACTERISTICS (continued)

($V_{IN} = +12V$ for the MAX5068B/E/F; $V_{IN} = +23.6V$ for the MAX5068A/C/D at startup, then reduces to $+12V$; $C_{IN} = C_{REG5} = 0.1\mu F$; $C_{VCC} = 1\mu F$; $R_{RT} = 100k\Omega$; $NDRV = floating$; $T_A = T_{MIN}$ to T_{MAX} , unless otherwise noted. Typical values are at $T_A = +25^\circ C$.) (Note 1)

PARAMETER	SYMBOL	CONDITIONS		MIN	TYP	MAX	UNITS
NDRV Switching Frequency	f_{SW}	(Note 6)	$f_{SW} = 10^{11}/(2 \times R_{RT})$, MAX5068A/B	25		1250	kHz
			$f_{SW} = 10^{11}/(4 \times R_{RT})$, MAX5068C/D/E/F	12.5		625	kHz
RT Voltage	V_{RT}	$40k\Omega < R_{RT} < 500k\Omega$			2.0		V
Oscillator Accuracy		$T_A = +25^\circ C$	$f_{OSC} \leq 500kHz$	-2.5		+2.5	%
			$f_{OSC} > 500kHz$	-4		+4	
		$T_A = -40^\circ C$ to $+125^\circ C$	$f_{OSC} \leq 500kHz$	-4.5		+4.5	
			$f_{OSC} > 500kHz$	-6		+6	
Maximum Duty Cycle	D_{MAX}	DT connected to REG5	MAX5068A/B		50		%
			MAX5068C/D/E/F		75		
DEAD-TIME CONTROL (DT)							
Dead Time	t_{DT}	$R_{DT} = 24.9k\Omega$			60		ns
Dead-Time Disable Voltage	$V_{DT_DISABLE}$			V_{REG5} - 0.5V			V
Dead-Time Regulation Voltage	V_{DT}				1.23		V
INTEGRATING FAULT PROTECTION (FLTINT)							
FLTINT Source Current	I_{FLTINT}	$V_{FLTINT} = 0$			60		μA
FLTINT Shutdown Threshold	V_{FLTINT_SD}	V_{FLTINT} rising			2.8		V
FLTINT Restart Threshold	V_{FLTINT_RS}	V_{FLTINT} falling			1.6		V
SLOPE COMPENSATION (SCOMP) MAX5068C/D/E/F Only							
Slope Compensation	V_{SLOPE}	$C_{SLOPE} = 100pF$, $R_{RT} = 110k\Omega$			15		mV/ μs
Slope-Compensation Range	V_{SLOPER}			0		90	mV/ μs
Slope-Compensation Voltage Range	V_{SCOMP}			0		2.7	V

Note 1: The MAX5068 is 100% tested at $T_A = +25^\circ C$. All limits over temperature are guaranteed by design.

Note 2: The MAX5068A/B are intended for use in universal-input power supplies. The internal clamp circuit is used to prevent the bootstrap capacitor (C1 in Figure 1) from charging to a voltage beyond the absolute maximum rating of the device when UVLO/EN is low. The maximum current to V_{IN} (hence to clamp) when UVLO is low (device is in shutdown) must be externally limited to 2mA. Clamp currents higher than 2mA may result in clamp voltages higher than 30V, thus exceeding the absolute maximum rating for V_{IN} . For the MAX5068C/D, do not exceed the 24V maximum operating voltage of the device.

Note 3: Reference voltage (V_{REF}) is measured with FB connected to COMP (see the *Functional Diagram*).

Note 4: The SYNC frequency must be at least 25% higher than the programmed oscillator frequency.

Note 5: The internal oscillator clock cycle.

Note 6: The MAX5068A/B driver switching frequency is one-half of the oscillator frequency. The MAX5068C/D/E/F driver switching frequency is one-quarter of the oscillator frequency.

High-Frequency, Current-Mode PWM Controller with Accurate Programmable Oscillator

MAX5068

Typical Operating Characteristics

($V_{IN} = +12V$ for the MAX5068B/E/F; $V_{IN} = +23.6V$ for MAX5068A/C/D at startup, then reduces to $+12V$; $C_{IN} = C_{REG5} = 0.1\mu F$; $C_{VCC} = 1\mu F$; $R_{RT} = 100k\Omega$; NDRV = floating; $V_{FB} = 0$; $V_{COMP} =$ floating; $V_{CS} = 0$; $T_A = +25^\circ C$, unless otherwise noted.)

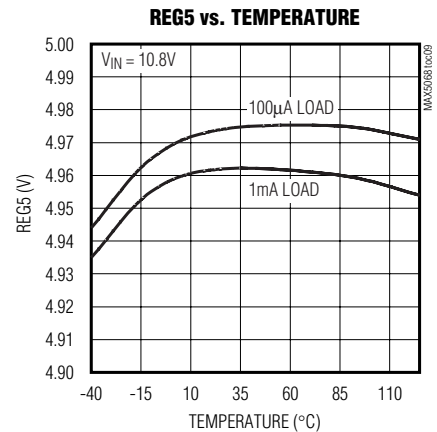
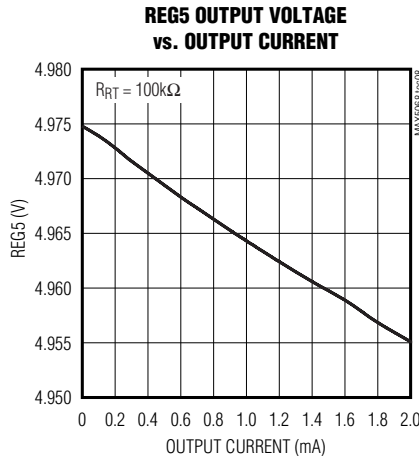
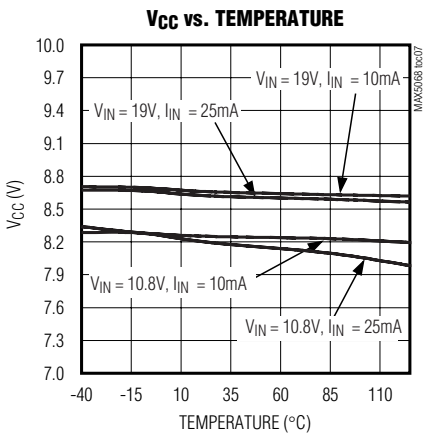
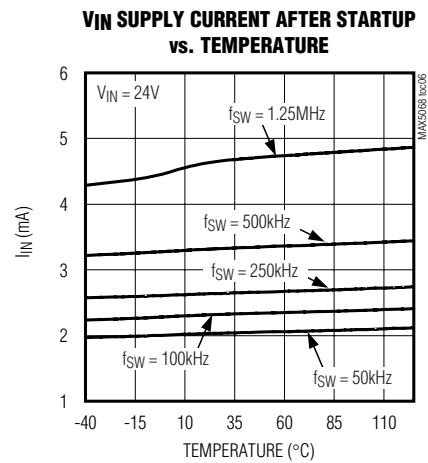
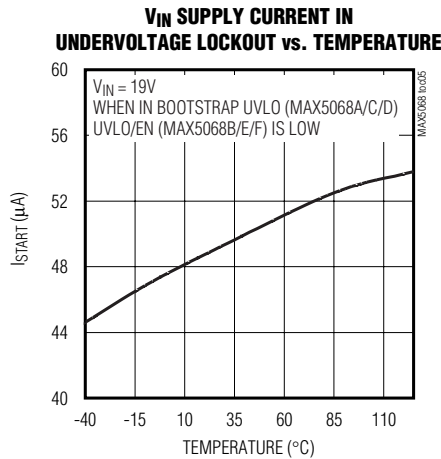
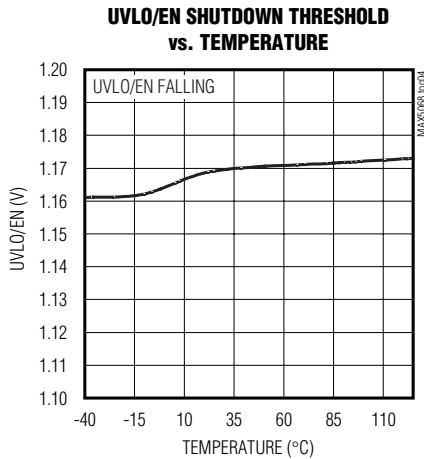
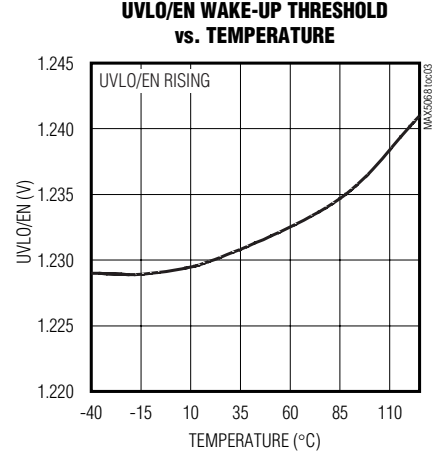
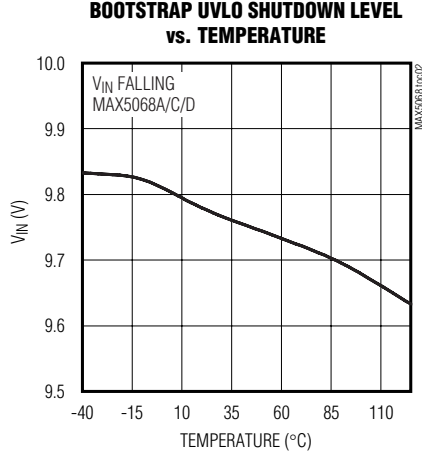
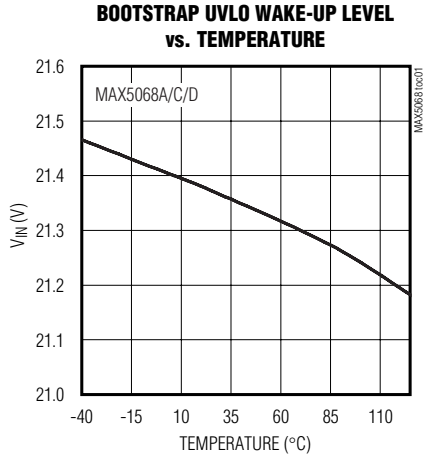

High-Frequency, Current-Mode PWM Controller with Accurate Programmable Oscillator

Typical Operating Characteristics (continued)

($V_{IN} = +12V$ for the MAX5068B/E/F; $V_{IN} = +23.6V$ for MAX5068A/C/D at startup, then reduces to $+12V$; $C_{IN} = C_{REG5} = 0.1\mu F$; $C_{VCC} = 1\mu F$; $R_{RT} = 100k\Omega$; $NDRV =$ floating; $V_{FB} = 0$; $V_{COMP} =$ floating; $V_{CS} = 0$; $T_A = +25^\circ C$, unless otherwise noted.)

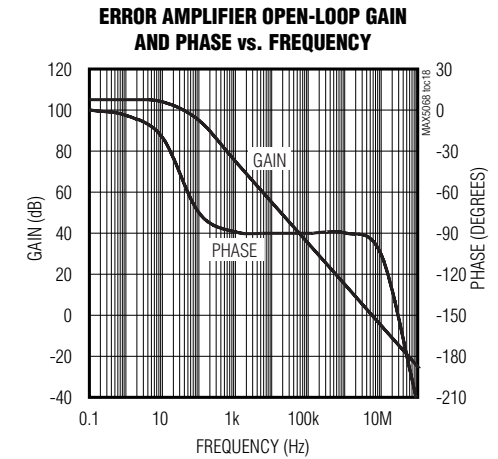
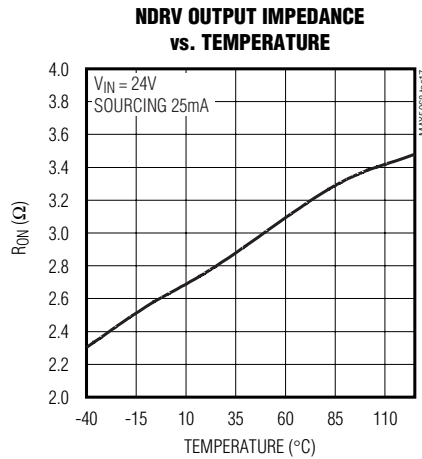
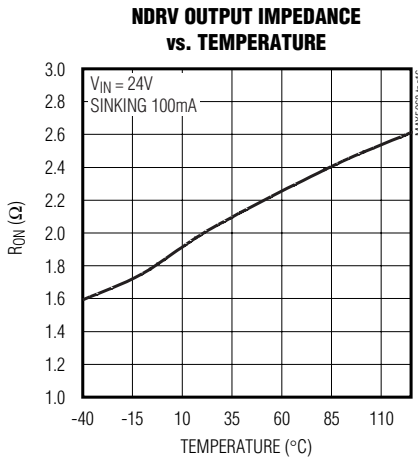
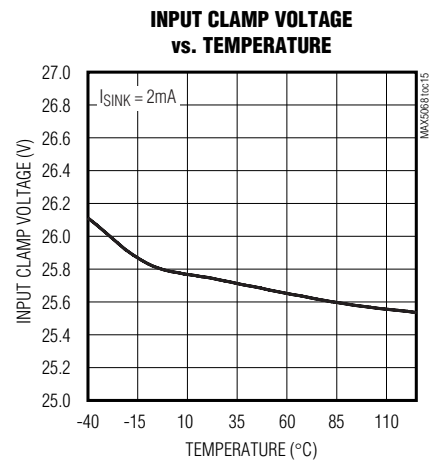
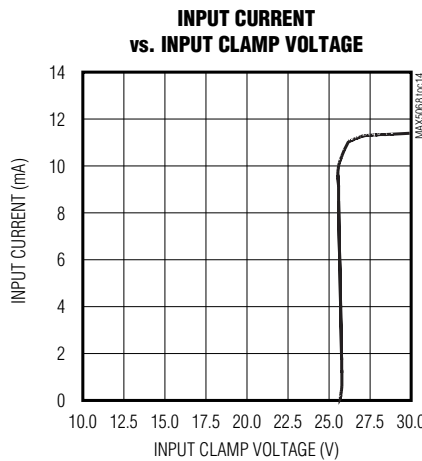
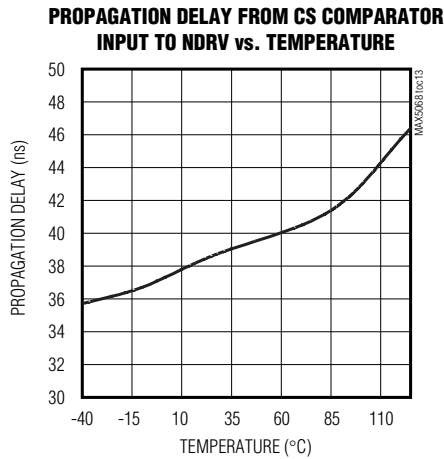
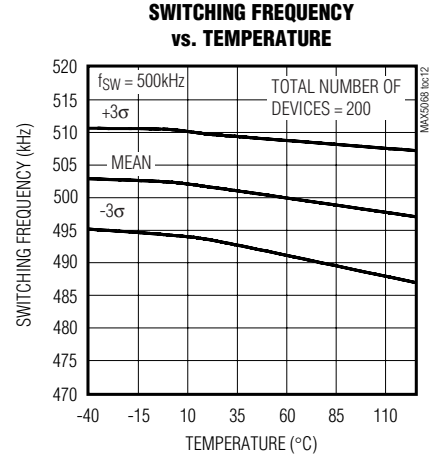
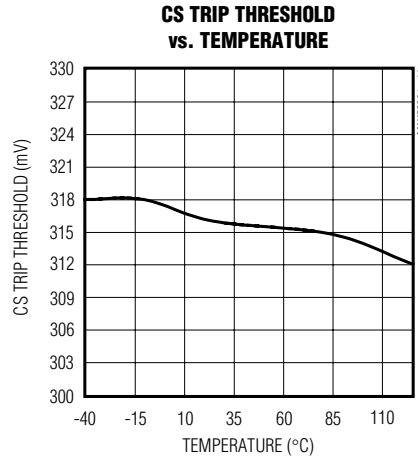
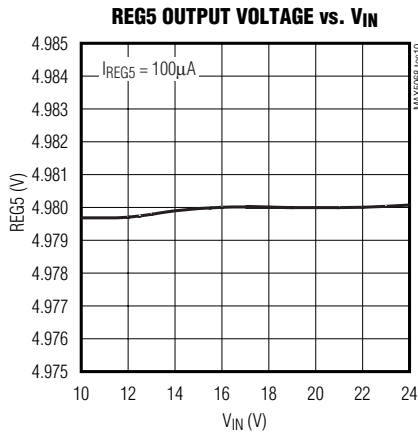

High-Frequency, Current-Mode PWM Controller with Accurate Programmable Oscillator

MAX5068

Typical Operating Characteristics (continued)

($V_{IN} = +12V$ for the MAX5068B/E/F; $V_{IN} = +23.6V$ for MAX5068A/C/D at startup, then reduces to $+12V$; $C_{IN} = C_{REG5} = 0.1\mu F$; $C_{VCC} = 1\mu F$; $R_{RT} = 100k\Omega$; NDRV = floating; $V_{FB} = 0$; $V_{COMP} =$ floating; $V_{CS} = 0$; $T_A = +25^\circ C$, unless otherwise noted.)

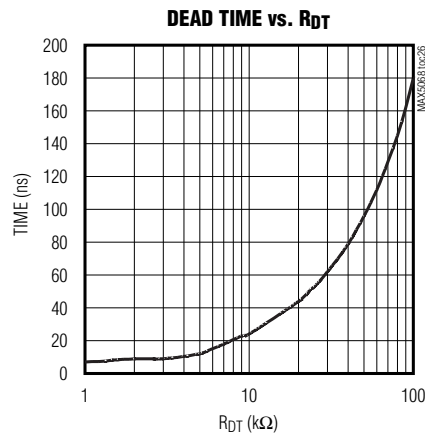
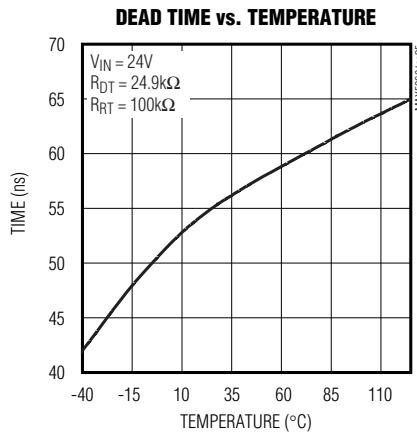
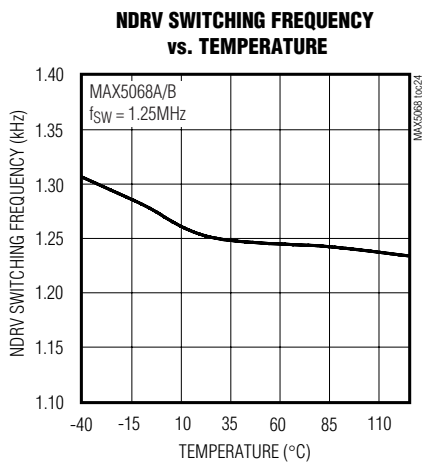
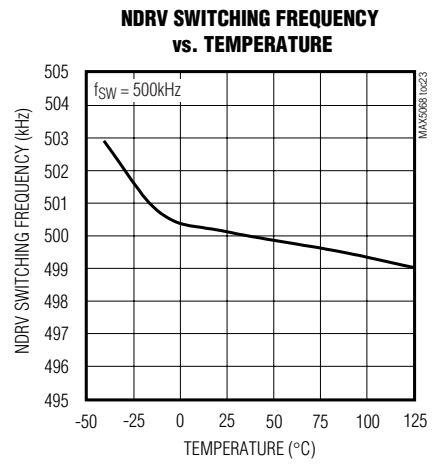
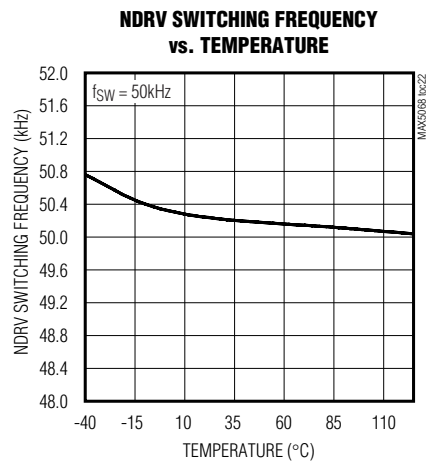
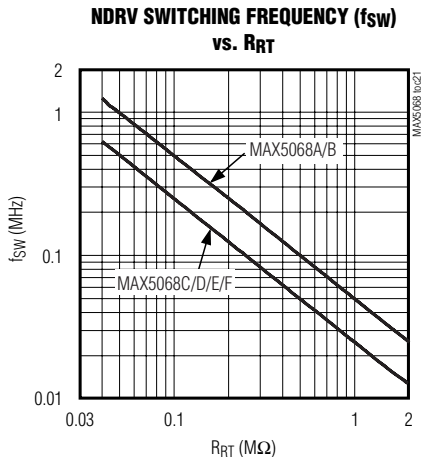
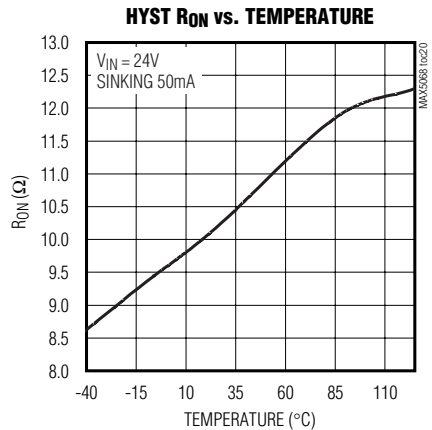
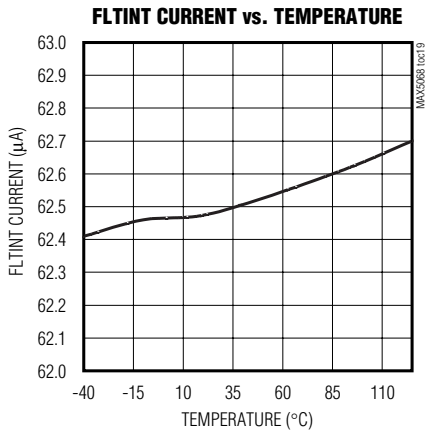

High-Frequency, Current-Mode PWM Controller with Accurate Programmable Oscillator

Pin Description

PIN			NAME	FUNCTION
MAX5068A MAX5068B	MAX5068C MAX5068E	MAX5068D MAX5068F		
1	1	1	RT	Oscillator-Timing Resistor Connection. Connect a resistor from RT to AGND to set the internal oscillator frequency.
2	2	—	SYNC	External-Clock Sync Input. Connect SYNC to AGND when not using an external clock.
3	—	2	HYST	Programmable Hysteresis Input
—	3	3	SCOMP	Slope-Compensation Capacitor Input. Connect a capacitor to AGND to set the slope compensation.
4	4	4	DT	Dead-Time Adjustment. Connect a resistor from DT to AGND to adjust NDRV dead time. Connect to REG5 for maximum duty cycle.
5	5	5	UVLO/EN	Externally Programmable Undervoltage Lockout. UVLO/EN programs the input start voltage. Drive UVLO/EN to AGND to disable the output.
6	6	6	FB	Error-Amplifier Inverting Input
7	7	7	COMP	Error-Amplifier Compensation Output
8	8	8	FLTINT	Fault-Integration Input. A capacitor connected to FLTINT charges with an internal 60 μ A current source during repeated current-limit events. Switching terminates when V_{FLTINT} reaches 2.9V. An external resistor connected in parallel discharges the capacitor. Switching resumes when V_{FLTINT} drops to 1.6V.
9	9	9	CS	Current-Sense Resistor Connection
10, 12	10, 12	10, 12	AGND	Analog Ground. Connect to PGND through a ground plane.
11	11	11	PGND	Power Ground. Connect to AGND through a ground plane.
13	13	13	NDRV	Gate-Driver Output. Connect the NDRV output to the gate of the external N-channel FET.
14	14	14	V _{CC}	9V Linear-Regulator Output. Decouple V _{CC} with a minimum 1 μ F ceramic capacitor to the AGND plane; also internally connected to the FET driver.
15	15	15	IN	Power-Supply Input. IN provides power for all internal circuitry. Decouple IN with a minimum 0.1 μ F ceramic capacitor to AGND (see the <i>Typical Operating Circuit</i>).
16	16	16	REG5	5V Linear-Regulator Output. Decouple to AGND with a 0.1 μ F ceramic capacitor.
EP	EP	EP	PAD	Exposed Pad. Connect to GND.

High-Frequency, Current-Mode PWM Controller with Accurate Programmable Oscillator

MAX5068

Detailed Description

The MAX5068 is a current-mode PWM controller for use in isolated and nonisolated power-supply applications. A bootstrap UVLO with a programmable hysteresis, very low startup, and low operating current result in high-efficiency universal-input power supplies. In addition to the internal bootstrap UVLO, the device also offers programmable input startup and turn-off voltages, programmed through the UVLO/EN input. When using the MAX5068 in the bootstrapped mode, if the power-supply output is shorted, the tertiary winding voltage drops below the 10V threshold, causing the bootstrap UVLO to turn off the gate drive to the external power MOSFET, reinitiating a startup sequence with soft-start.

The MAX5068 includes a cycle-by-cycle current limit that turns off the gate drive to the external MOSFET during an overcurrent condition. The MAX5068 integrating fault protection reduces average power dissipation during persistent fault conditions (see the *Integrating Fault Protection* section).

The MAX5068 features a very accurate, wide-range, programmable oscillator that simplifies and optimizes the design of the magnetics. The MAX5068A/C/D are well suited for universal-input (rectified 85V_{AC} to 265V_{AC}) or telecom (-36V_{DC} to -72V_{DC}) power supplies. The MAX5068B/E/F are well suited for low-input voltage (10.8V_{DC} to 24V_{DC}) power supplies.

The MAX5068 high-frequency, universal input, offline/telecom, current-mode PWM controller integrates all the building blocks necessary for implementing AC-DC and DC-DC fixed-frequency power supplies. Isolated or non-isolated power supplies are easily constructed using either primary- or secondary-side regulation. Current-mode control with leading-edge blanking simplifies control-loop design, and an external slope-compensation control stabilizes the current loop when operating at duty cycles above 50% (MAX5068C/D/E/F). The MAX5068A/B limit the maximum duty cycle to 50% for use in single-ended forward converters. The MAX5068C/D/E/F allow duty cycles up to 75% for use in flyback converters.

An input undervoltage lockout (UVLO) programs the input-supply startup voltage and ensures proper operation during brownout conditions. An external voltage-divider programs the supply startup voltage. The MAX5068A/B/D/F feature a programmable UVLO hysteresis. The MAX5068A/C/D feature an additional internal bootstrap UVLO with large hysteresis that requires a minimum startup voltage of 23.6V. The MAX5068B/E/F start

up from a minimum voltage of 10.8V. Internal digital soft-start reduces output-voltage overshoot at startup.

A single external resistor programs the switching frequency from 12.5kHz to 1.25MHz. The MAX5068A/B/C/E provide a SYNC input for synchronization to an external clock. The maximum FET driver duty cycle is 50% for the MAX5068A/B, and 75% for the MAX5068C/D/E/F. Integrating fault protection ignores transient overcurrent conditions for a set length of time. The length of time is programmed by an external capacitor. The internal thermal-shutdown circuit protects the device if the junction temperature should exceed +170°C.

Power supplies designed with the MAX5068 use a high-value startup resistor, R1, which charges a reservoir capacitor, C1 (Figure 1). During this initial period, while the voltage is less than the internal bootstrap UVLO threshold, the device typically consumes only 47μA of quiescent current. This low startup current and the large bootstrap UVLO hysteresis help to minimize the power dissipation across R1, even at the high end of the universal AC input voltage (265V_{AC}).

The MAX5068 includes a cycle-by-cycle current limit that turns off the gate to the external MOSFET during an overcurrent condition. When using the MAX5068A/C/D in the bootstrap mode (if the power-supply output is shorted), the tertiary winding voltage drops below the 9.74V bootstrap UVLO to turn off the gate to the external power MOSFET. This reinitiates a startup sequence with soft-start.

Current-Mode Control

The MAX5068 offers a current-mode control operation feature, such as leading-edge blanking with a dual internal path that only blanks the sensed current signal applied to the input of the PWM controller. The current-limit comparator monitors CS at all times and provides cycle-by-cycle current limit without being blanked. The leading-edge blanking of the CS signal prevents the PWM comparator from prematurely terminating the on cycle. The CS signal contains a leading-edge spike that results from the MOSFET gate charge current, and the capacitive and diode reverse-recovery current of the power circuit. Since this leading-edge spike is normally lower than the current-limit comparator threshold, current limiting is provided under all conditions.

Use the MAX5068C/D/E/F in flyback applications where wide line voltage and load-current variations are expected. Use the MAX5068A/B for forward/flyback converters where the maximum duty must be limited to less than 50%.

High-Frequency, Current-Mode PWM Controller with Accurate Programmable Oscillator

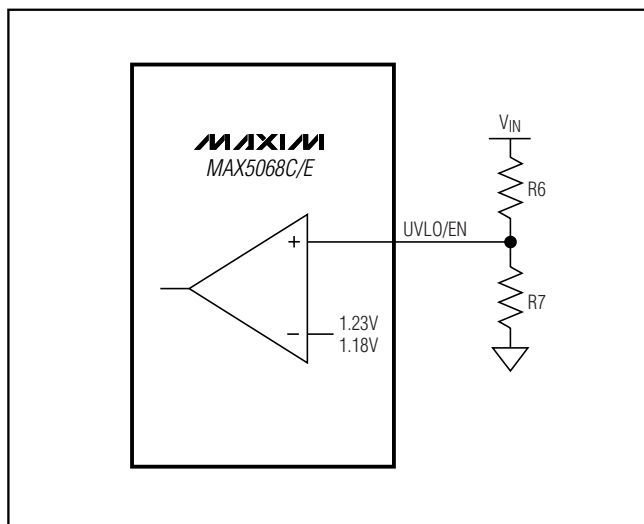

Figure 2. Setting the MAX5068C/E Undervoltage Lockout Threshold

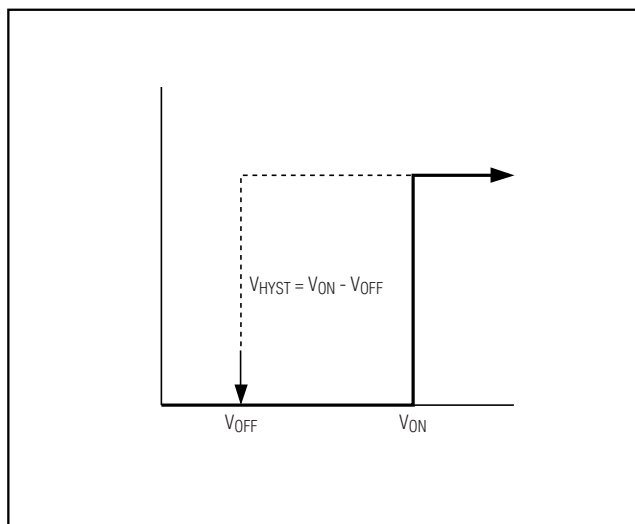

Figure 3. MAX5068 Hysteresis

MAX5068A/B/D/F UVLO with Programmable Hysteresis

In addition to programmable undervoltage lockout during startup, the MAX5068A/B/D/F incorporate a UVLO/EN hysteresis that allows the user to set a voltage (V_{OFF}) to disable the controller (see Figure 3).

At the beginning of the startup sequence, UVLO/EN is below the 1.23V threshold, Q1 turns on connecting R_{HYST} to GND (Figure 4). Once the UVLO 1.23V threshold is crossed, Q1 turns off, resulting in the series combination of R_6 , R_{HYST} , and R_7 , placing the MAX5068 in normal operating condition.

Calculate the turn-on voltage (V_{ON}) by using the following formula:

$$R_6 = \left(\frac{V_{ON}}{V_{ULR2}} - 1 \right) \times R_{HYST}$$

where V_{ULR2} is the UVLO/EN's 1.23V rising threshold.

Choose an R_{HYST} value in the 20k Ω range.

The MAX5068 turns off when the MAX5068 UVLO/EN falls below the 1.18V falling threshold. The turn-off voltage (V_{OFF}) is then defined as:

$$R_7 = R_6 / \left(\frac{V_{OFF}}{V_{ULF2}} - 1 \right) - R_{HYST}$$

where V_{ULF2} is the 1.18V UVLO/EN falling threshold.

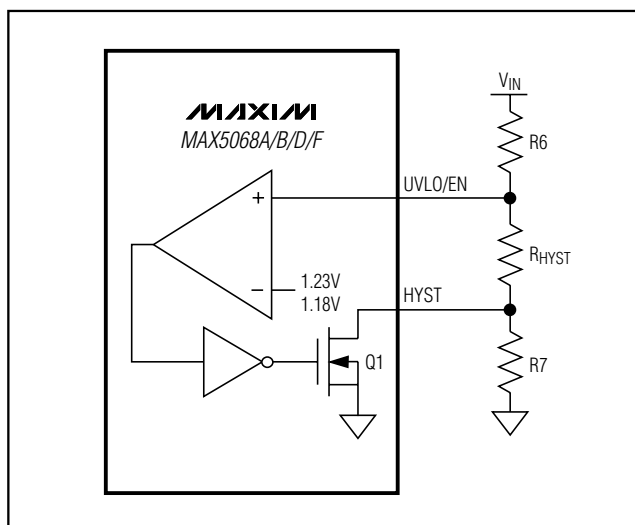

Figure 4. Setting the MAX5068A/B/D/F Turn-On/Turn-Off Voltages

Bootstrap Undervoltage Lockout (MAX5068A/C/D Only)

In addition to the externally programmable UVLO function offered by the MAX5068, the MAX5068A/C/D feature an additional internal bootstrap UVLO for use in high-voltage power supplies (see the *Functional Diagram*). This allows the device to bootstrap itself during initial power-up. The MAX5068A/C/D start when V_{IN} exceeds the bootstrap UVLO threshold of 23.6V.

High-Frequency, Current-Mode PWM Controller with Accurate Programmable Oscillator

During startup, the UVLO circuit keeps the PWM comparator, ILIM comparator, oscillator, and output driver shut down to reduce current consumption. Once V_{IN} reaches 23.6V, the UVLO circuit turns on both the PWM and ILIM comparators, as well as the oscillator, and allows the output driver to switch. When V_{IN} drops below 9.7V, the UVLO circuit shuts down the PWM comparator, ILIM comparator, oscillator, and output driver returning the MAX5068A/C/D to the startup mode.

MAX5068A/C/D Startup Operation

Normally, V_{IN} is derived from the tertiary winding of the transformer. However, at startup there is no energy delivered through the transformer, hence, a special bootstrap sequence is required. Figure 5 shows the voltages on V_{IN} and V_{CC} during startup. Initially, both V_{IN} and V_{CC} are zero. After the input voltage is applied, C1 charges through the startup resistor, R1, to an intermediate voltage (see Figure 1). At this point, the internal regulator begins charging C3 (see Figure 5). Only 47 μ A of the current supplied by R1 is used by the MAX5068A/C/D. The remaining input current charges C1 and C3. The charging of C3 stops when the V_{CC} voltage reaches approximately 9.5V. The voltage across C1 continues rising until it reaches the wake-up level of 23.6V. Once V_{IN} exceeds the bootstrap UVLO threshold, NDRV begins switching the MOSFET and energy is transferred to the secondary and tertiary outputs. If the voltage on the tertiary output builds to higher than 9.74V (the bootstrap UVLO lower threshold), startup ends and sustained operation commences.

If V_{IN} drops below 9.74V before startup is complete, the device goes back to low-current UVLO. If this occurs, increase the value of C1 to store enough energy to allow for the voltage at the tertiary winding to build up.

Startup Time Considerations for Power Supplies Using the MAX5068A/C/D

The V_{IN} bypass capacitor, C1, supplies current immediately after wakeup (see Figure 1). The size of C1 and the connection configuration of the tertiary winding determine the number of cycles available for startup. Large values of C1 increase the startup time and also supply extra gate charge for more cycles during initial startup. If the value of C1 is too small, V_{IN} drops below 9.74V because NDRV does not have enough time to switch and build up sufficient voltage across the tertiary output that powers the device. The device goes back into UVLO and does not start. Use low-leakage capacitors for C1 and C3.

Generally, offline power supplies keep typical startup times to less than 500ms, even in low-line conditions (85V_{AC} input for universal offline applications or 36V_{DC}

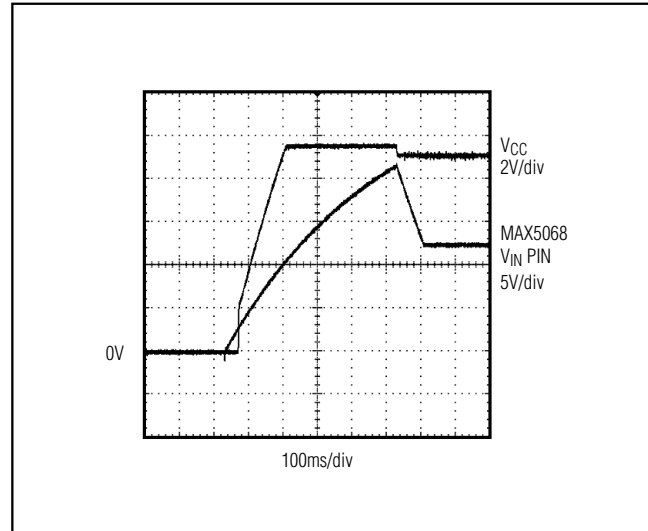

Figure 5. V_{IN} and V_{CC} During Startup When Using the MAX5068 in Bootstrapped Mode (Also see Figure 1)

for telecom applications). Size the startup resistor, R1, to supply both the maximum startup bias of the device (90 μ A) and the charging current for C1 and C3. The bypass capacitor, C3, must charge to 9.5V, and C1 must charge to 24V, within the desired time period of 500ms. Because of the internal soft-start time of the MAX5068, C1 must store enough charge to deliver current to the device for at least 2047 oscillator clock cycles. To calculate the approximate amount of capacitance required, use the following formula:

$$I_g = Q_{gtot} \times f_{sw}$$

$$C1 = \frac{(I_{IN} + I_g) \times t_{SS}}{V_{HYST}}$$

where I_{IN} is the MAX5068's internal supply current after startup (2.5mA typ), Q_{gtot} is the total gate charge for Q1, f_{sw} is the MAX5068's programmed switching frequency, V_{HYST} is the bootstrap UVLO hysteresis (12V), and t_{SS} is the internal soft-start time ($2047 \times 1 / f_{OSC}$).

Example: $I_g = (8nC) (250kHz) \cong 2.0mA$

$$f_{OSC} = 2 \times 250kHz$$

$$\text{Soft-start duration} = 2047 \times (1 / f_{OSC}) = 4.1ms$$

$$C1 = \frac{(2.5mA + 2mA) (4.1ms)}{12V} = 1.54\mu F$$

Use a 2.2 μ F ceramic capacitor for C1.

High-Frequency, Current-Mode PWM Controller with Accurate Programmable Oscillator

MAX5068

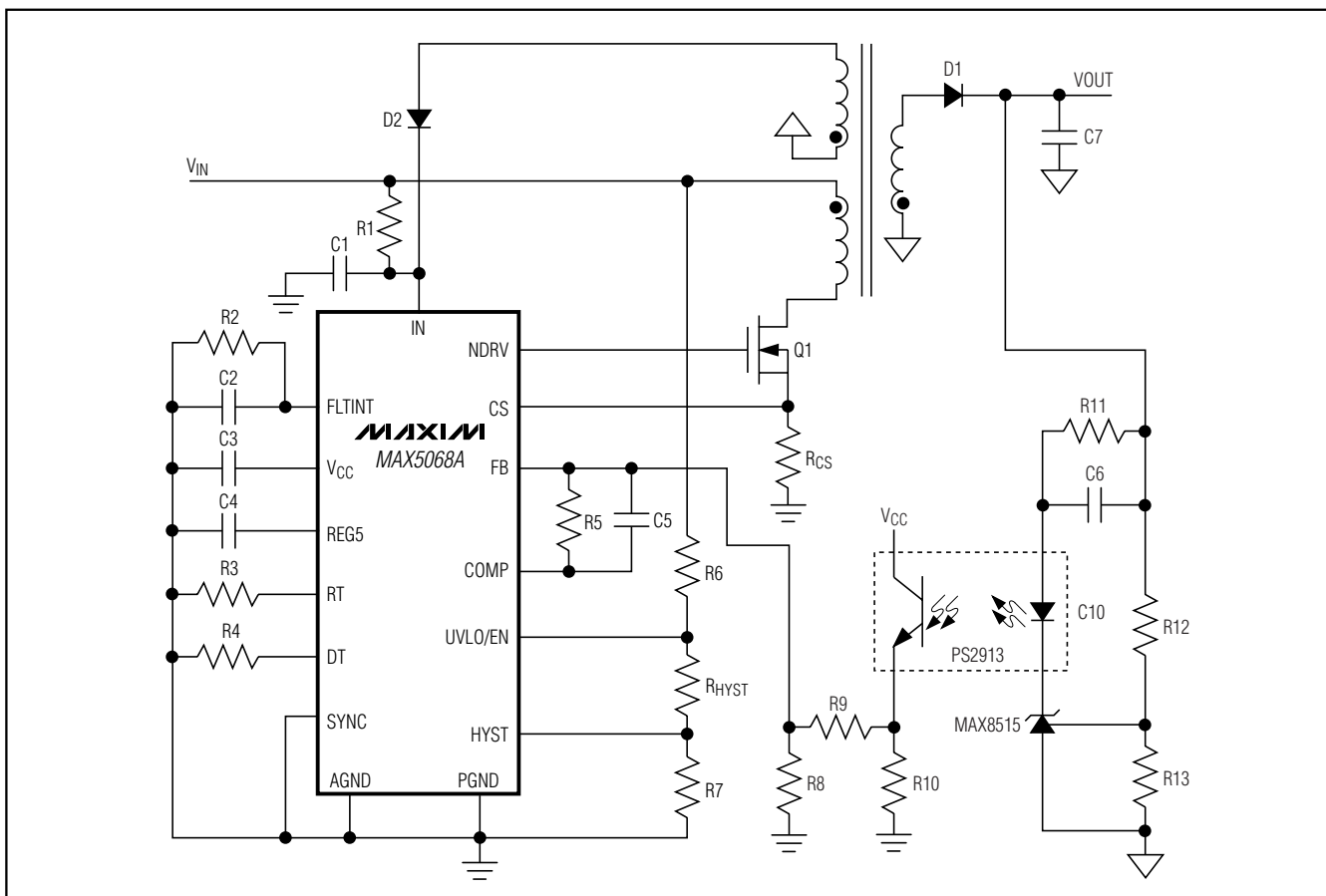

Figure 6. Secondary-Side, Regulated, Isolated Power Supply

Assuming $C1 > C3$, calculate the value of R1 as follows:

$$I_{C1} = \frac{V_{SUVR} \times C1}{500ms}$$

$$R1 \cong \frac{V_{IN(MIN)} - 0.5 \times V_{SUVR}}{I_{C1} + I_{START}}$$

where V_{SUVR} is the bootstrap UVLO wakeup level (23.6V max), $V_{IN(MIN)}$ is the minimum input supply voltage for the application (36V for telecom), and I_{START} is the V_{IN} supply current at startup (90 μ A, max).

For example:

$$I_{C1} = \frac{24V \times 2.2\mu F}{500ms} = 106\mu A$$

$$R1 \cong \frac{36V - 12V}{106\mu A + 90\mu A} = 122.4k\Omega$$

To minimize power loss on this resistor, choose a higher value for R1 than the one calculated above (if a longer startup time can be tolerated).

The above startup method is applicable to a circuit similar to the one shown in Figure 1. In this circuit, the tertiary winding has the same phase as the output windings. Thus, the voltage on the tertiary winding at any given time is proportional to the output voltage and goes through the same soft-start period as the output voltage. The minimum discharge time of C1 from 22V to 10V must be greater than the soft-start time (t_{SS}).

Oscillator/Switching Frequency

Use an external resistor at RT to program the MAX5068 internal oscillator frequency from 50kHz to 2.5MHz. The MAX5068A/B output switching frequency is one-half of the programmed oscillator frequency with a 50% duty cycle. The MAX5068C/D/E/F output switching frequency is one-quarter of the programmed oscillator frequency with a 75% duty cycle.

High-Frequency, Current-Mode PWM Controller with Accurate Programmable Oscillator

Use the following formula to calculate the internal oscillator frequency:

$$f_{\text{osc}} = \frac{10^{11}}{R_{\text{RT}}}$$

where f_{osc} is the oscillator frequency and R_{RT} is a resistor connected from RT to AGND.

Choose the appropriate resistor at RT to calculate the desired output switching frequency (f_{sw}):

$$R_{\text{RT}} = \frac{10^{11}}{2f_{\text{sw}}} \text{ for the MAX5068A/B and}$$

$$R_{\text{RT}} = \frac{10^{11}}{4f_{\text{sw}}} \text{ for the MAX5068C/D/E/F}$$

The MAX5068A/B and the MAX5068C/D/E/F have programmable output switching frequencies from 25kHz to 1.25MHz and 12.5kHz to 625kHz, respectively.

Dead-Time Adjustment

The MAX5068 programmable dead-time function (Figure 7) allows additional flexibility in optimizing magnetics design and overcoming parasitic effects. The MAX5068A/B and the MAX5068C/D/E/F have a maximum 50% and 75% duty cycle, respectively. In many applications, the duty cycle of the external MOSFET may need to be slightly decreased to prevent saturation in the transformer's primary. The dead time can be configured from 30ns to $1 / (0.5 \times f_{\text{sw}})$ when programming the MAX5068. Connect a resistor between DT and AGND to set the desired dead time using the following formula:

$$\text{Dead time} = \frac{60}{29.4} \times R_{\text{DT}}(\text{ns})$$

where R_{DT} is in $k\Omega$ and the dead time is in ns.

Connect DT to REG5 to remove the delay and achieve the MAX5068 maximum duty cycles.

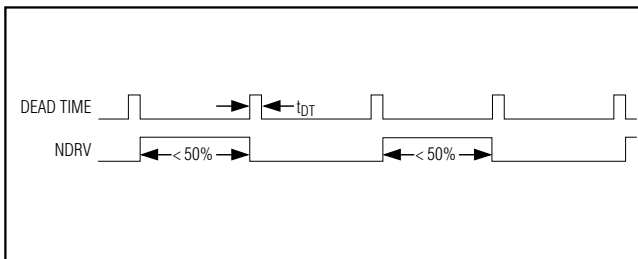

Figure 7. MAX5068 NDRV Dead-Time Timing Diagram

External Synchronization (MAX5068A/B/C/E)

The MAX5068A/B/C/E can be synchronized using an external clock at the SYNC input. For proper frequency synchronization, the SYNC's input frequency must be at least 25% higher than the MAX5068A/B/C/E programmed internal oscillator frequency. Connect SYNC to AGND when not using an external clock.

Integrating Fault Protection

The integrating fault-protection feature allows transient overcurrent conditions to be ignored for a programmable amount of time, giving the power supply time to behave like a current source to the load. For example, this can occur under load current transients when the control loop requests maximum current to keep the output voltage from going out of regulation. Program the fault-integration time by connecting an external suitably sized capacitor to the FLTINT. Under sustained overcurrent faults, the voltage across this capacitor ramps up towards the FLTINT shutdown threshold (typically 2.8V). Once the threshold is reached, the power supply shuts down. A high-value bleed resistor connected in parallel with the FLTINT capacitor allows it to discharge towards the restart threshold (typically 1.6V). Once this threshold is reached, the supply restarts with a new soft-start cycle.

Note that cycle-by-cycle current limiting is provided at all times by CS with a threshold of 314mV (typ). The fault-integration circuit forces a 60 μ A current onto FLTINT each time that the current-limit comparator is tripped (see the *Functional Diagram*). Use the following formula to calculate the value of the capacitor necessary for the desired shutdown time of the circuit:

$$C_{\text{FLTINT}} \cong \frac{I_{\text{FLTINT}} \times t_{\text{SH}}}{2.8\text{V}}$$

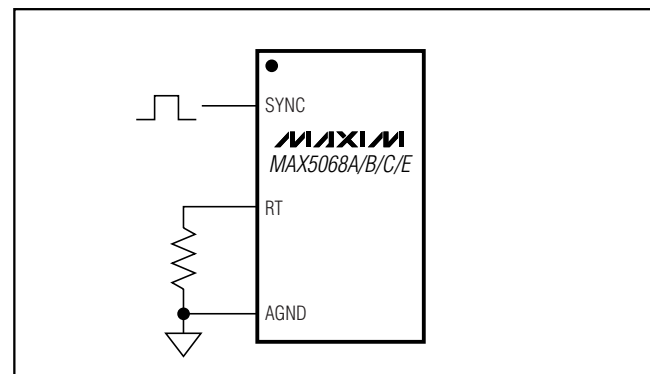

Figure 8. External Synchronization of the MAX5068A/B/C/E

High-Frequency, Current-Mode PWM Controller with Accurate Programmable Oscillator

where $I_{FLTINT} = 60\mu\text{A}$, t_{SH} is the desired fault-integration time during which current-limit events from the current-limit comparator are ignored. For example, a $0.1\mu\text{F}$ capacitor gives a fault-integration time of 4.7ms.

This is an approximate formula. Some testing may be required to fine-tune the actual value of the capacitor. To calculate the recovery time, use the following formula:

$$R_{FLTINT} \cong \frac{t_{RT}}{0.595 \times C_{FLTINT}}$$

where t_{RT} is the desired recovery time.

Choose $t_{RT} = 10 \times t_{SH}$. Typical values for t_{SH} range from a few hundred microseconds to a few milliseconds.

Soft-Start

The MAX5068 soft-start feature allows the load voltage to ramp up in a controlled manner, eliminating output-voltage overshoot. Soft-start begins after UVLO is deasserted. The voltage applied to the noninverting node of the amplifier ramps from 0 to 1.23V in 2047 oscillator clock cycles (soft-start timeout period). Unlike other devices, the MAX5068 reference voltage to the internal amplifier is soft-started. This method results in superior control of the output voltage under heavy- and light-load conditions.

Internal Regulators

Two internal linear regulators power the MAX5068 internal and external control circuits. V_{CC} powers the external N-channel MOSFET and is internally set to approximately 9.5V. The REG5 5V regulator has a 1mA sourcing capability and may be used to provide power to external circuitry. Bypass V_{CC} and REG5 with $1\mu\text{F}$ and $0.1\mu\text{F}$ high quality capacitors, respectively. Use lower value ceramics in parallel to bypass other unwanted noise signals. Bootstrapped operation requires startup through a bleed resistor. Do not excessively load the regulators while the MAX5068 is in the power-up mode. Overloading the outputs can cause the MAX5068 to fail upon startup.

N-Channel MOSFET Switch Driver

NDRV drives an external N-channel MOSFET. The NDRV output is supplied by the internal regulator (V_{CC}), which is internally set to approximately 9.5V. For the universal input-voltage range, the MOSFET used must be able to withstand the DC level of the high-line input voltage plus the reflected voltage at the primary of the transformer. For most applications that use the discontinuous flyback topology, a MOSFET rated at 600V is required. NDRV can source/sink in excess of 650mA/1000mA peak cur-

rent. Therefore, select a MOSFET that yields acceptable conduction and switching losses.

Error Amplifier

The MAX5068 includes an internal error amplifier that can regulate the output voltage in the case of a nonisolated power supply (Figure 1). Calculate the output voltage using the following equation:

$$V_{OUT} = \left(1 + \frac{R_8}{R_9}\right) \times V_{REF}$$

where $V_{REF} = 1.23\text{V}$. The amplifier's noninverting input internally connects to a digital soft-start reference voltage. This forces the output voltage to come up in an orderly and well-defined manner under all load conditions.

Slope Compensation (MAX5068C/D/E/F)

The MAX5068C/D/E/F use an internal-ramp generator for slope compensation. The internal-ramp signal resets at the beginning of each cycle and slews at the rate programmed by the external capacitor connected at SCOMP and the resistor at R_T . Adjust the MAX5068 slew rate up to $90\text{mV}/\mu\text{s}$ using the following equation:

$$SR = \frac{165 \times 10^{-6}}{R_{RT} \times C_{SCOMP}} \text{ (mV}/\mu\text{s)}$$

where R_{RT} is the external resistor at R_T that sets the oscillator frequency and C_{SCOMP} is the capacitor at SCOMP.

PWM Comparator

The PWM comparator uses the instantaneous current, the error amplifier, and the slope compensation to determine when to switch NDRV off. In normal operation, the N-channel MOSFET turns off when:

$$I_{PRIMARY} \times R_{CS} > V_{EA} - V_{OFFSET} - V_{SCOMP}$$

where $I_{PRIMARY}$ is the current through the N-channel MOSFET, V_{EA} is the output voltage of the internal amplifier, V_{OFFSET} is the 1.6V internal DC offset and V_{SCOMP} is the ramp function starting at zero and slewing at the programmed slew rate (SR). When using the MAX5068 in a forward-converter configuration, the following conditions must be met to avoid current-loop subharmonic oscillations:

$$\frac{N_S}{N_P} \times \frac{K \times R_{CS} \times V_{OUT}}{L} = SR$$

where $K = 0.75$ and N_S and N_P are the number of turns on the secondary and primary side of the transformer, respectively. L is the secondary filter inductor. When

High-Frequency, Current-Mode PWM Controller with Accurate Programmable Oscillator

optimally compensated, the current loop responds to input-voltage transients within one cycle.

Current Limit

The current-sense resistor (R_{CS}), connected between the source of the MOSFET and ground, sets the current limit. The CS input has a voltage trip level (V_{CS}) of 314mV. Use the following equation to calculate the value of R_{CS} :

$$R_{CS} = \frac{V_{CS}}{I_{PRI}}$$

where I_{PRI} is the peak current in the primary that flows through the MOSFET at full load.

When the voltage produced by this current (through the current-sense resistor) exceeds the current-limit comparator threshold, the MOSFET driver (NDRV) quickly terminates the current on-cycle. In most cases, a small RC filter is required to filter out the leading-edge spike on the sense waveform. Set the corner frequency to a few MHz above the switching frequency.

Applications Information

Layout Recommendations

Keep all PC board traces carrying switching currents as short as possible, and minimize current loops.

For universal AC input design, follow all applicable safety regulations. Offline power supplies may require UL, VDE, and other similar agency approvals. Contact these agencies for the latest layout and component rules.

Typically, there are two sources of noise emission in a switching power supply: high di/dt loops and high dv/dt surfaces. For example, traces that carry the drain current often form high di/dt loops. Similarly, the heatsink of the MOSFET presents a dv/dt source, thus minimize the surface area of the heatsink as much as possible.

To achieve best performance and to avoid ground loops, use a solid ground-plane connection.

High-Frequency, Current-Mode PWM Controller with Accurate Programmable Oscillator

Typical Operating Circuit

MAX5068

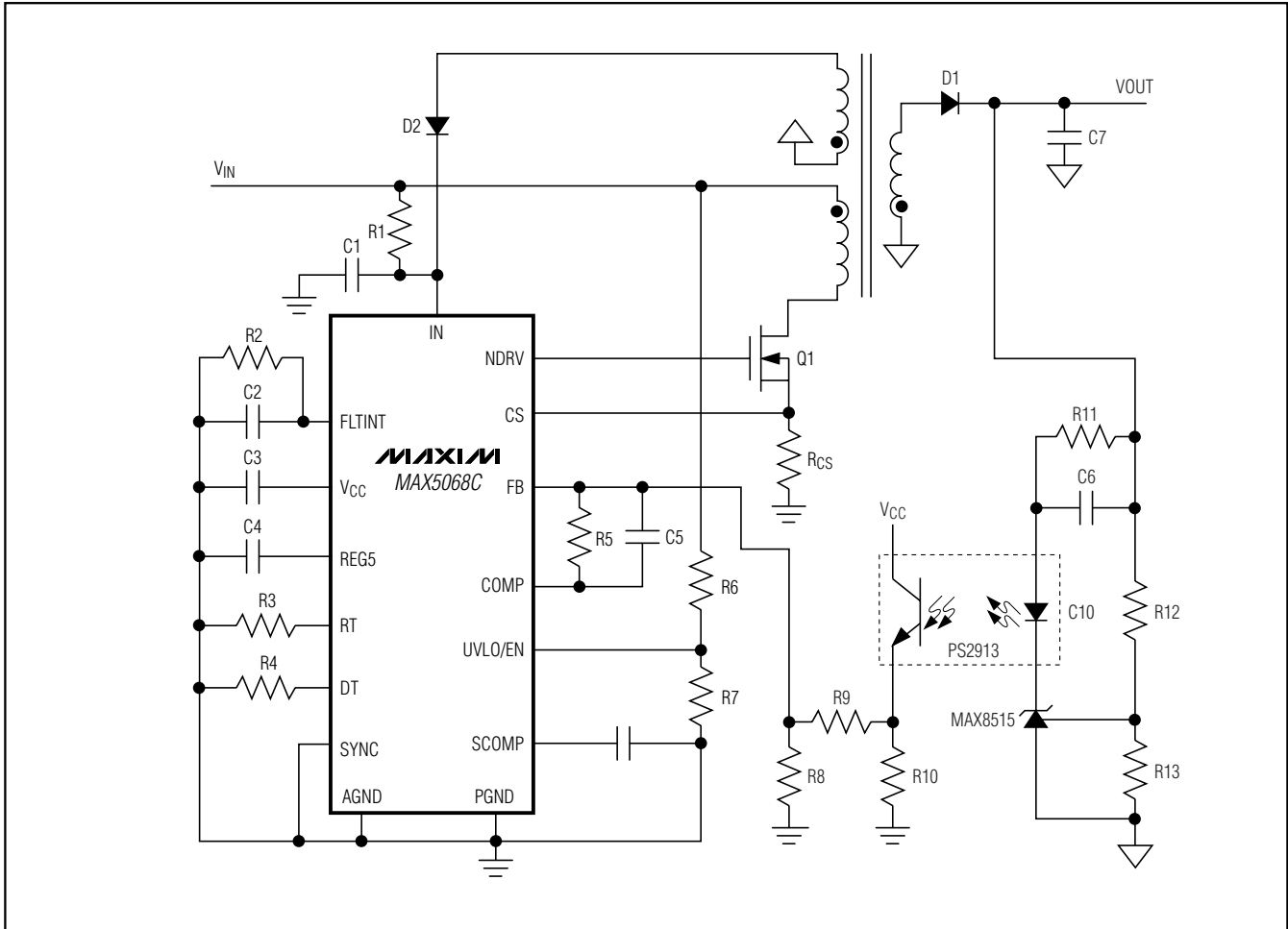

Selector Guide

PART NUMBER	MAX DUTY CYCLE	BOOTSTRAP UVLO	STARTUP VOLTAGE (V)	PROGRAMMABLE UVLO HYSTERESIS	OSCILLATOR SYNC	SLOPE COMPENSATION
MAX5068A	50%	Yes	23.6	Yes	Yes	No
MAX5068B	50%	No	10.8	Yes	Yes	No
MAX5068C	75%	Yes	23.6	No	Yes	Yes
MAX5068D	75%	Yes	23.6	Yes	No	Yes
MAX5068E	75%	No	10.8	No	Yes	Yes
MAX5068F	75%	No	10.8	Yes	No	Yes

High-Frequency, Current-Mode PWM Controller with Accurate Programmable Oscillator

Functional Diagram

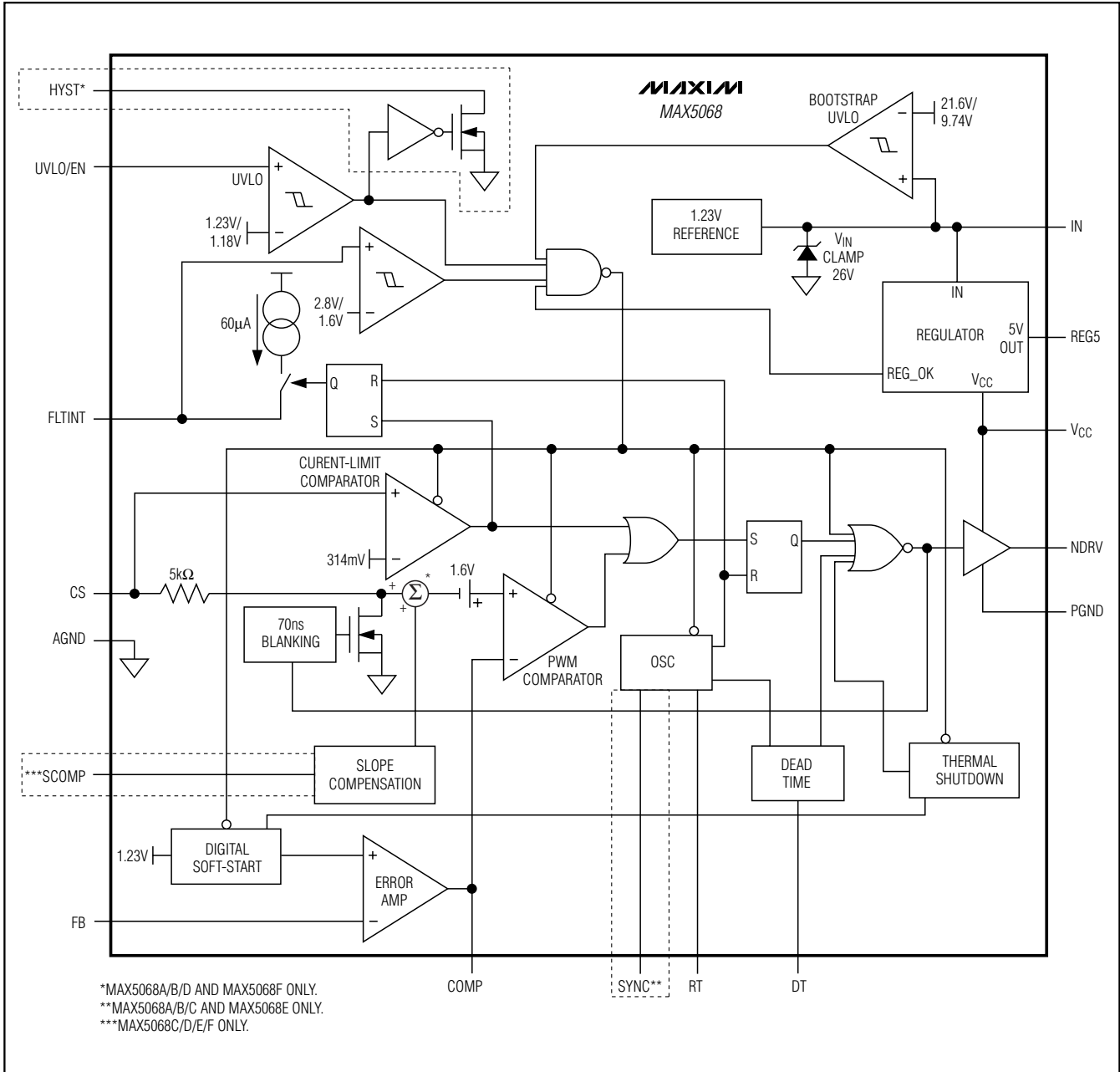

High-Frequency, Current-Mode PWM Controller with Accurate Programmable Oscillator

Pin Configurations (continued)

MAX5068

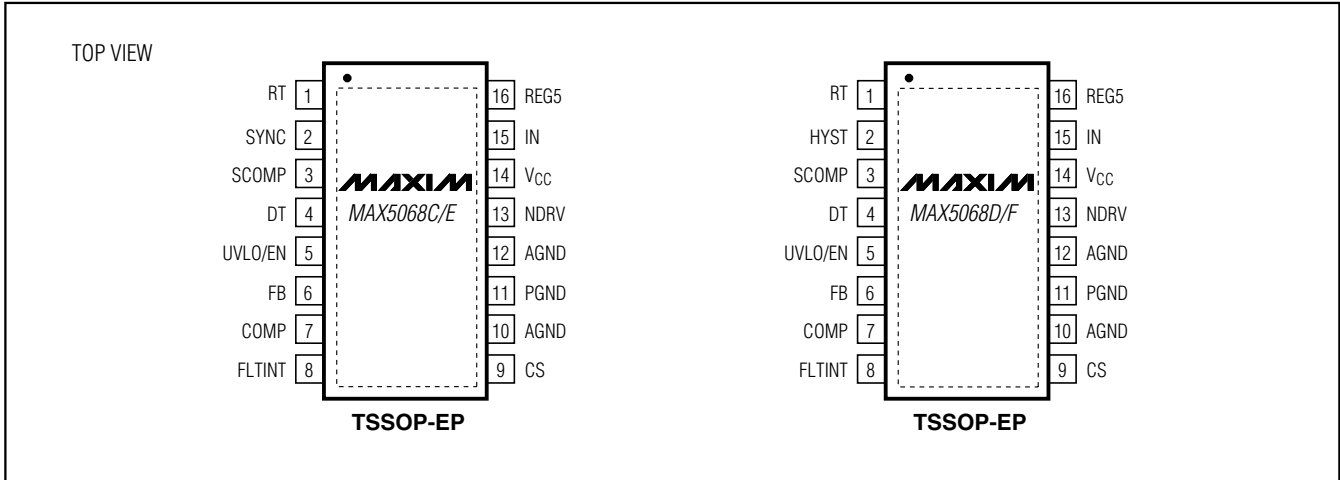

Chip Information

TRANSISTOR COUNT: 4,266

PROCESS: BICMOS

High-Frequency, Current-Mode PWM Controller with Accurate Programmable Oscillator

Package Information

(The package drawing(s) in this data sheet may not reflect the most current specifications. For the latest package outline information, go to www.maxim-ic.com/packages.)

COMMON DIMENSIONS

SYMBOL	MILLIMETERS		INCHES	
	MIN.	MAX.	MIN.	MAX.
A	--	1.10	--	0.043
A1	0.05	0.15	0.002	0.006
A2	0.85	0.95	0.033	0.037
b	0.19	0.30	0.007	0.012
b1	0.19	0.25	0.007	0.010
c	0.090	0.20	0.004	0.008
c1	0.090	0.135	0.004	0.0053
D	SEE VARIATIONS		SEE VARIATIONS	
E	4.30	4.50	0.169	0.177
e	0.65 BSC		0.026 BSC	
H	6.25	6.50	0.246	0.256
L	0.50	0.70	0.020	0.028
N	SEE VARIATIONS		SEE VARIATIONS	
Y	2.85	3.15	0.112	0.124
α	0°	8°	0°	8°

JEDEC	N	VARIATIONS				
		MILLIMETERS		INCHES		
MO-153	N	MIN.	MAX.	MIN.	MAX.	
ABT-1	14	D	4.90	5.10	0.193	0.201
		X	2.95	3.25	0.116	0.128
ABT	16	D	4.90	5.10	0.193	0.201
		X	2.85	3.15	0.112	0.124
ACT	20	D	6.40	6.60	0.252	0.260
		X	4.00	4.34	0.157	0.171
AET	28	D	9.60	9.80	0.378	0.386
		X	5.35	5.65	0.211	0.222

NOTES:
 1. DIMENSIONS D AND E DO NOT INCLUDE FLASH.
 2. MOLD FLASH OR PROTRUSIONS NOT TO EXCEED 0.15mm PER SIDE.
 3. CONTROLLING DIMENSION: MILLIMETERS.
 4. MEETS JEDEC OUTLINE MO-153. SEE JEDEC VARIATIONS TABLE.
 5. 'N' REFERS TO NUMBER OF LEADS.
 6. EXPOSED PAD FLUSH WITH BOTTOM OF PACKAGE WITHIN .002".
 THE LEAD TIPS MUST LIE WITHIN A SPECIFIED ZONE. THIS TOLERANCE ZONE IS DEFINED BY TWO PARALLEL PLANES. ONE PLANE IS THE SEATING PLANE, DATUM [-C-J]; THE OTHER PLANE IS AT THE SPECIFIED DISTANCE FROM [-C-J] IN THE DIRECTION INDICATED.

DALLAS SEMICONDUCTOR **MAXIM**
 PROPRIETARY INFORMATION
 TITLE: PACKAGE OUTLINE, TSSOP, 4.40 MM BODY EXPOSED PAD
 APPROVAL: _____ DOCUMENT CONTROL NO. 21-0108 REV. D 1/1

TSSOP 4.4mm BODY EPS

Maxim cannot assume responsibility for use of any circuitry other than circuitry entirely embodied in a Maxim product. No circuit patent licenses are implied. Maxim reserves the right to change the circuitry and specifications without notice at any time.

20 **Maxim Integrated Products, 120 San Gabriel Drive, Sunnyvale, CA 94086 408-737-7600**